

TITLE		ZTP65-30GRF02		DATE		10.11.15	
PART NAME		6.5inch Touch Panel		TOLERANCE		±0.3mm	
NO		DATE		REVISIONS		SIGN	

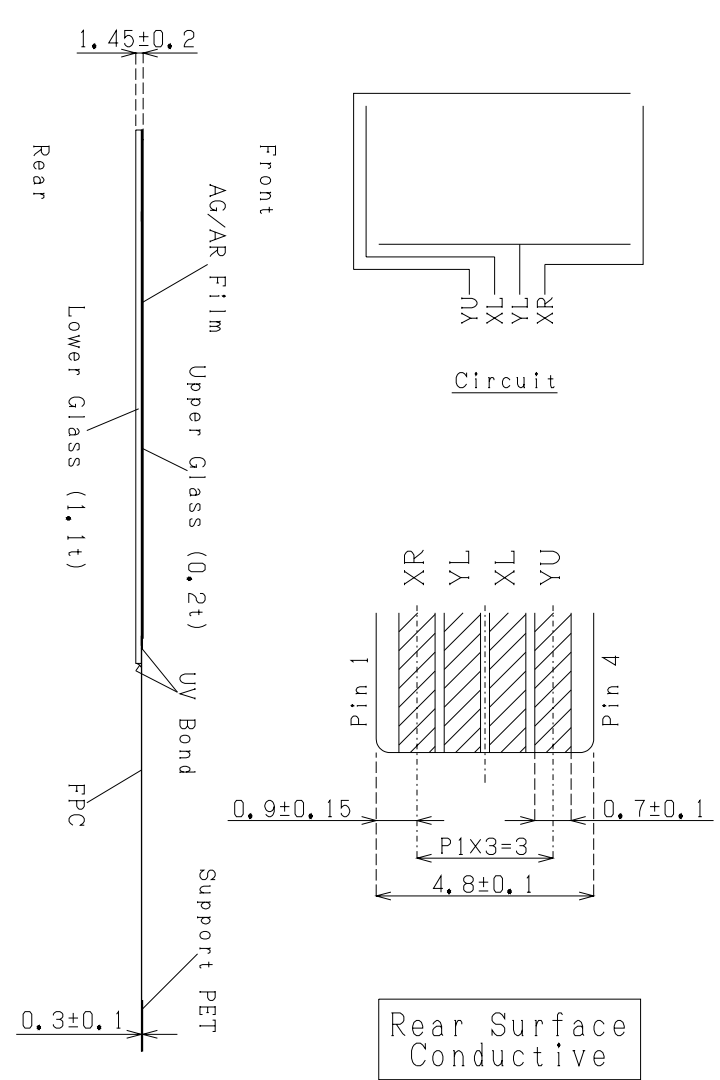

9	Active Area	157.5
7.5	Viewing Area	160.5
7	Electrode Area	161.5
2.5±0.5	AG/AR Film	168±0.5
		173±0.3

TITLE		ZTP7-08GRF01		DATE		'05.10.12	
PART NAME		7inch Touch Panel		TOLERANCE		±0.3mm	
NO		DATE		REVISIONS		SIGN	
△							
△							
△							
DRAWN		CHECKED		APPROVED			

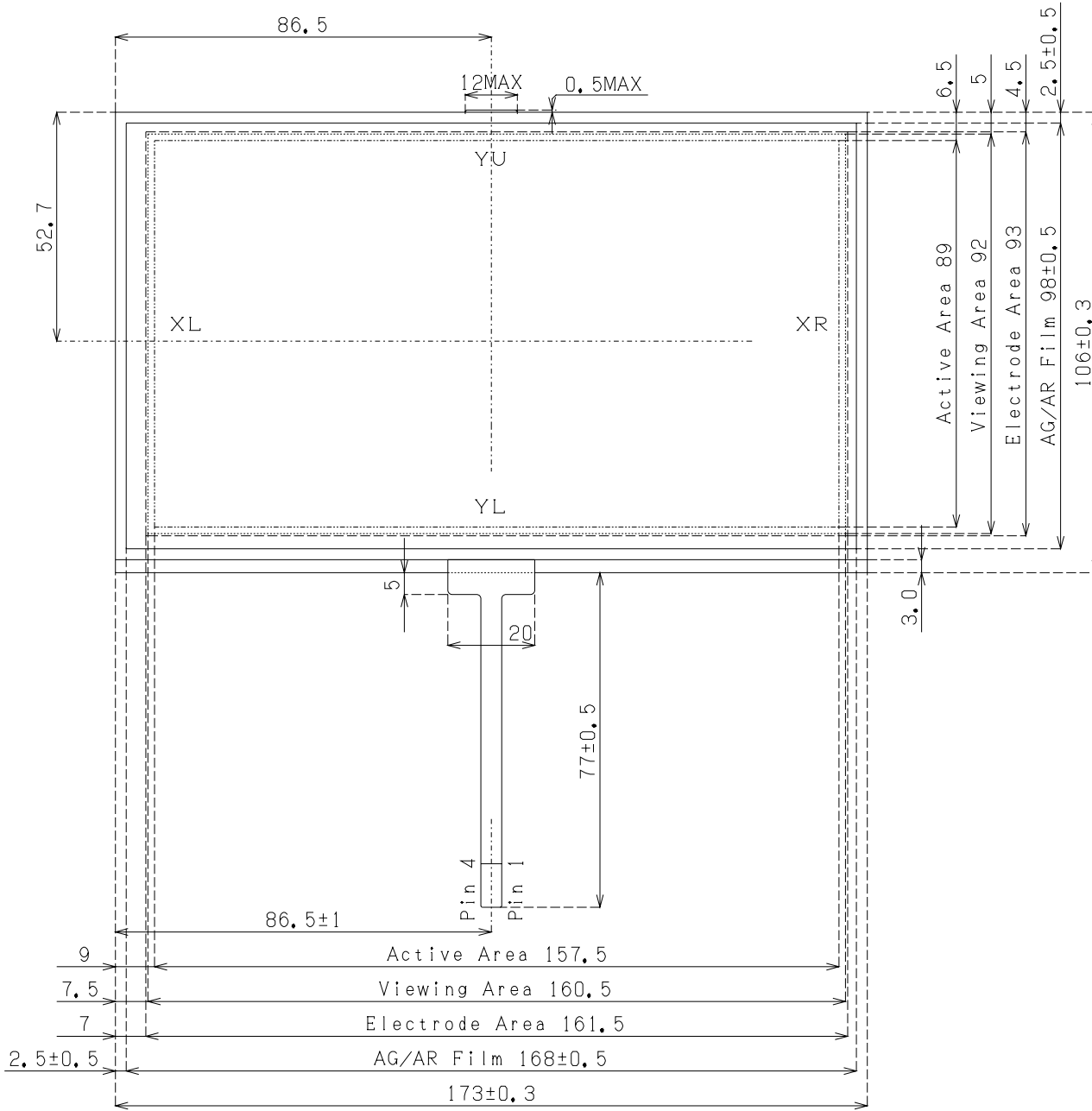
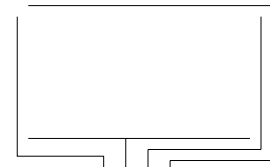
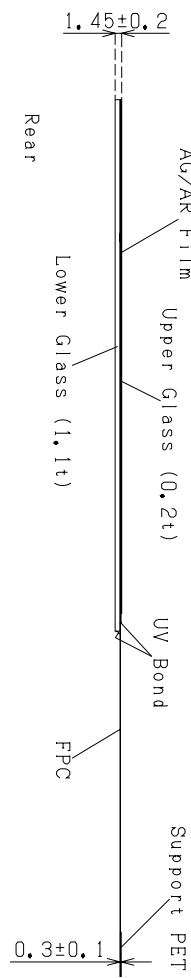
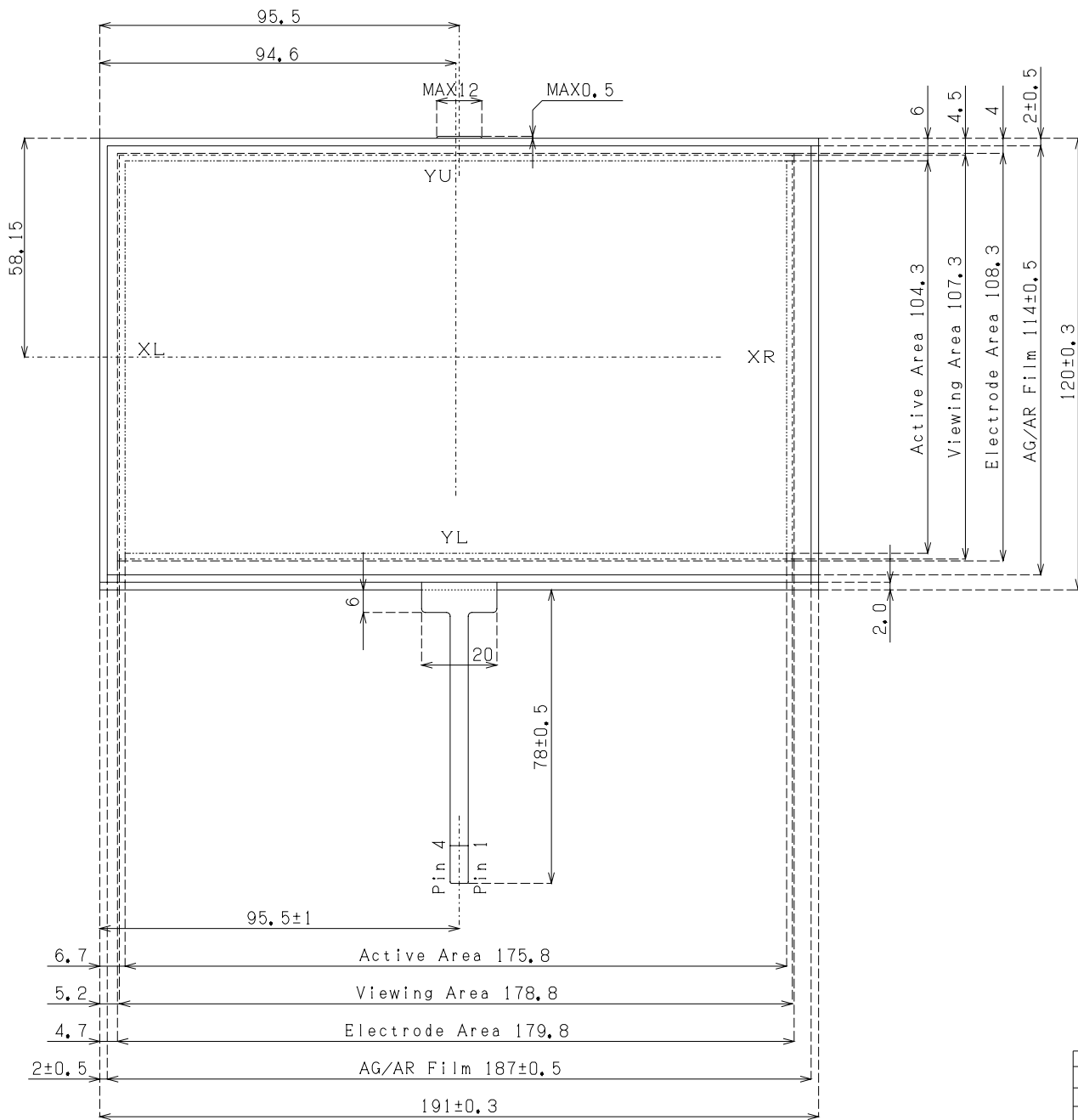

Circuit

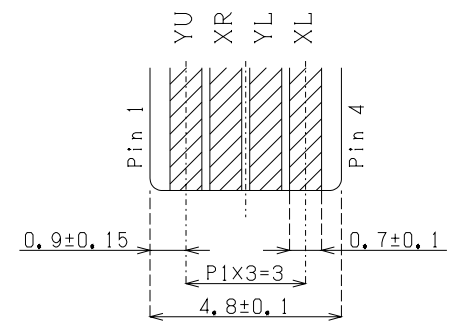

Rear Surface Conductive

6.7	Active Area	175.8
5.2	Viewing Area	178.8
4.7	Electrode Area	179.8
2±0.5	AG/AR Film	187±0.5
		191±0.3

TITLE		ZTP8-54GRF01		DATE		'11.9.8	
PART NAME		8inch Touch Panel		TOLERANCE		±0.3mm	
NO		DATE		REVISIONS		SIGN	
NO		DATE		REVISIONS		SIGN	
NO		DATE		REVISIONS		SIGN	
DRAWN		CHECKED		APPROVED			

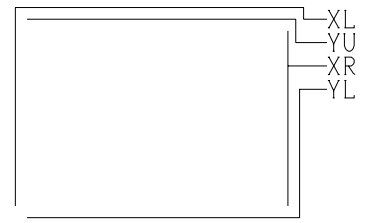
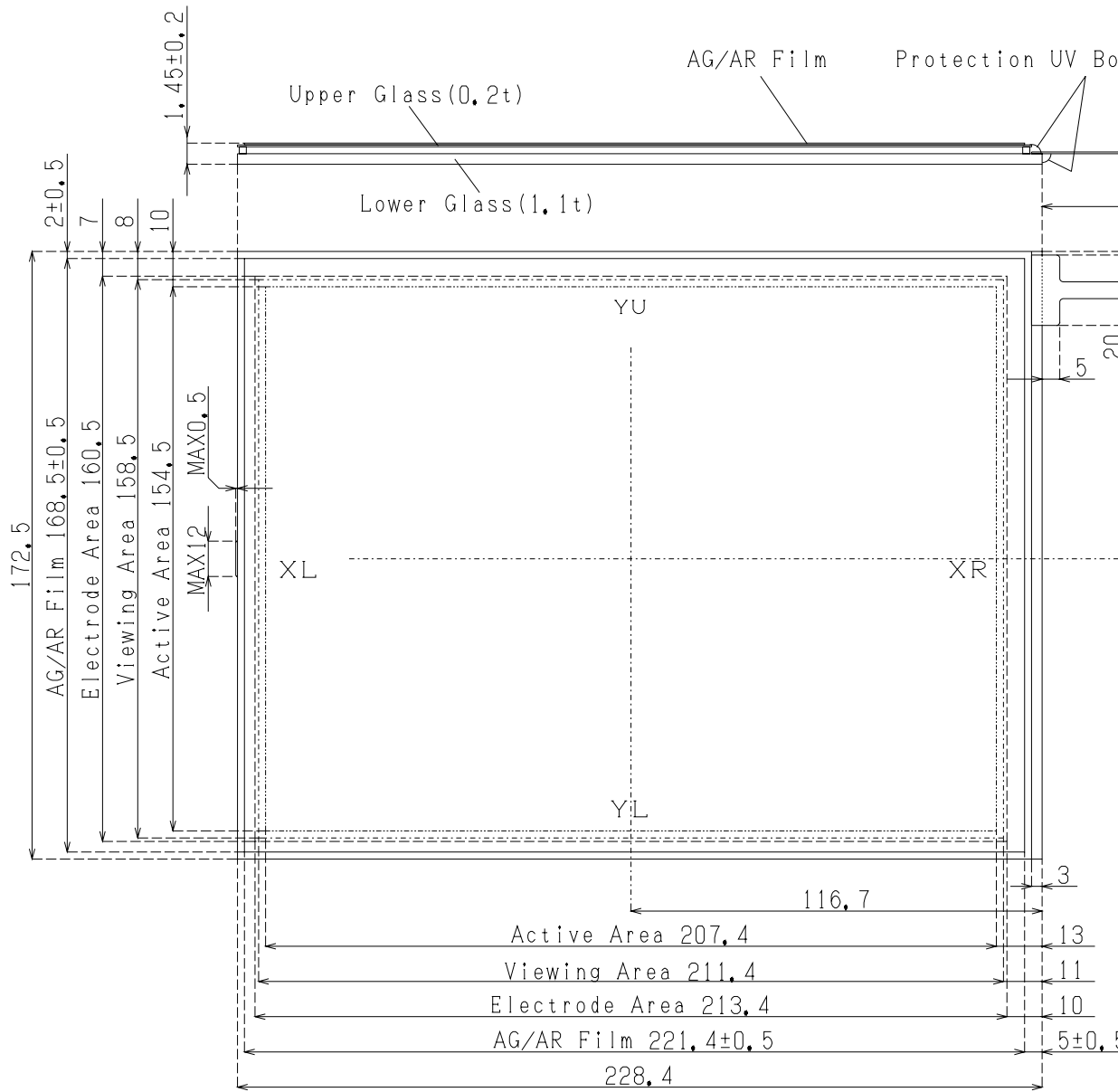

Circuit

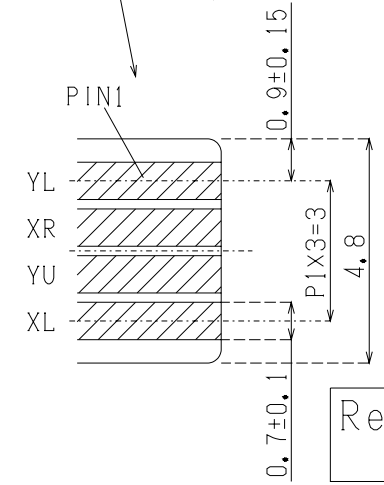

TITLE		ZTP104-04GRF01		DATE		10.2.24	
PART NAME		10.4inch Touch Panel		TOLERANCE		±0.3mm	
NO	DATE	REVISIONS	SI	GN	DRAWN	CHECKED	APPROVED

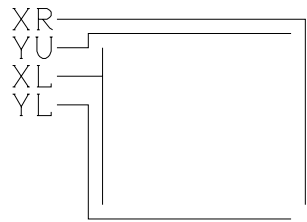

Rear Surface Conductive

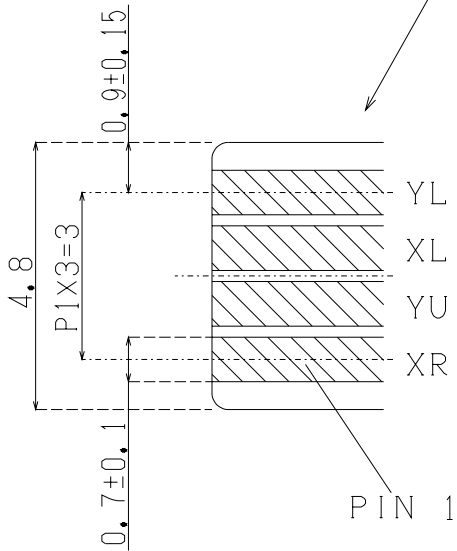

Flexible Printed Circuit Board
 Support PET
 Protection UV Bond
 AG/AR Film
 Upper Glass(0.2t)
 Lower Glass(1.1t)

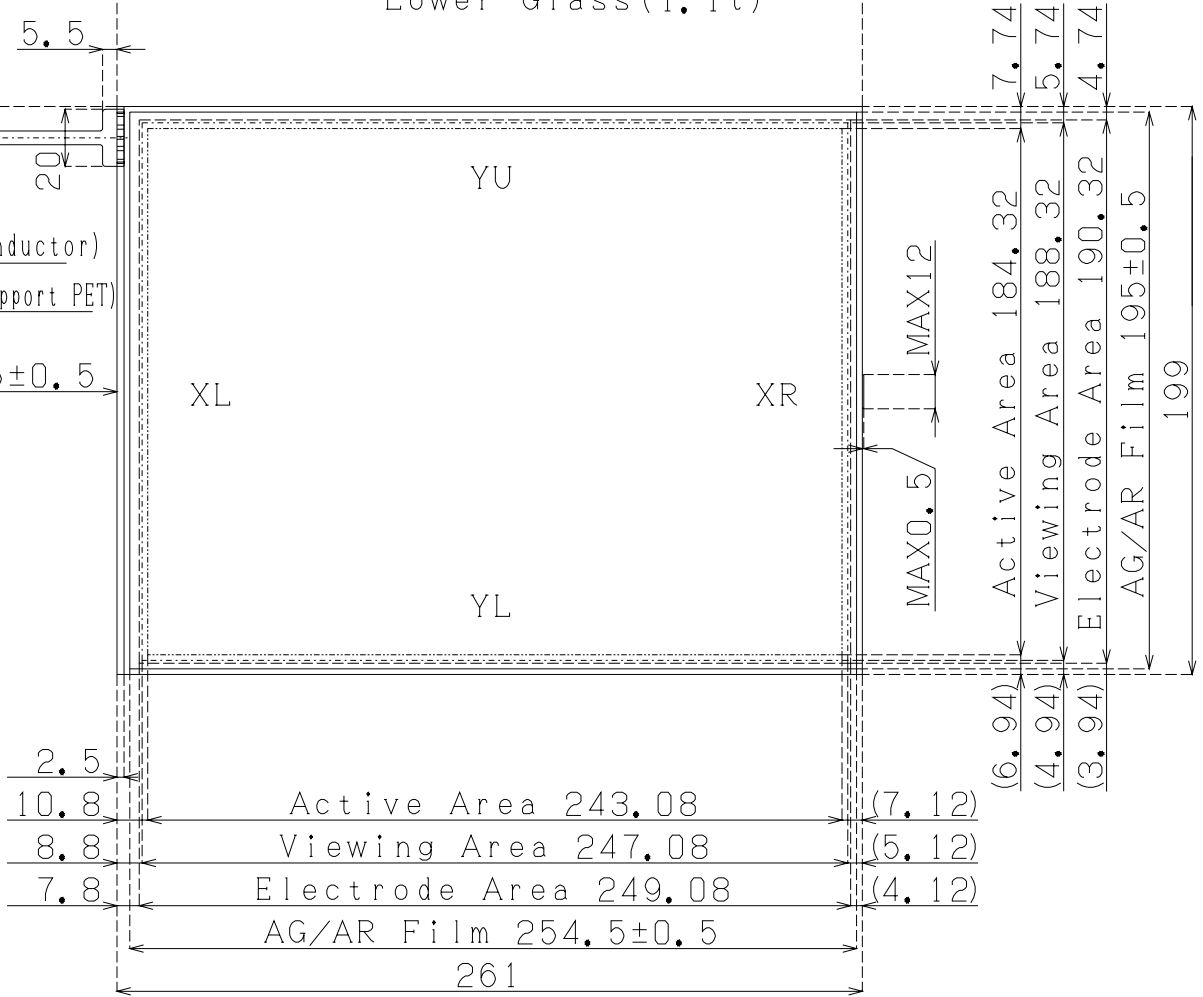
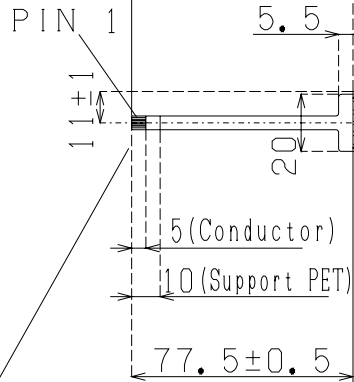

1.45±0.2

MAX12
 MAX0.5

7.74
 5.74
 4.74
 Active Area 184.32
 Viewing Area 188.32
 Electrode Area 190.32
 AG/AR Film 195±0.5
 199

2.5
 10.8
 8.8
 7.8
 Active Area 243.08 (7.12)
 Viewing Area 247.08 (5.12)
 Electrode Area 249.08 (4.12)
 AG/AR Film 254.5±0.5
 261

TITLE		ZTP121-24GRF01		DATE '08.7.1	
PART NAME		12.1inch Touch Panel		TOLERANCE ±0.3mm	
NO	DATE	REVISIONS	SIGN	DRAWN	CHECKED

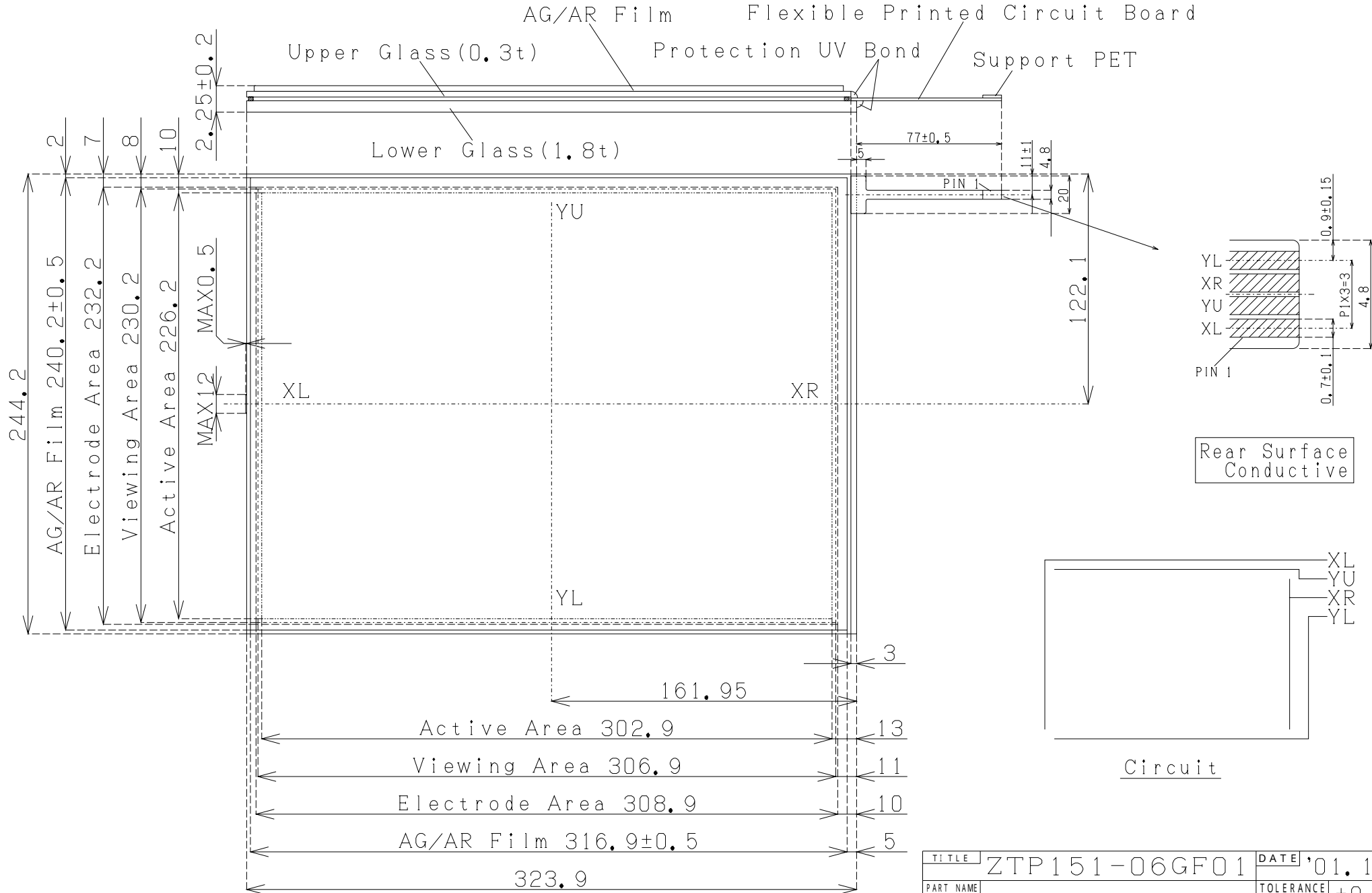

TITLE		ZTP151-06GF01		DATE		'01.11.6	
PART NAME		15.1inch Touch Panel		TOLERANCE		±0.3mm	
NO	DATE	REVISIONS	SI	GN	DRAWN	CHECKED	APPROVED

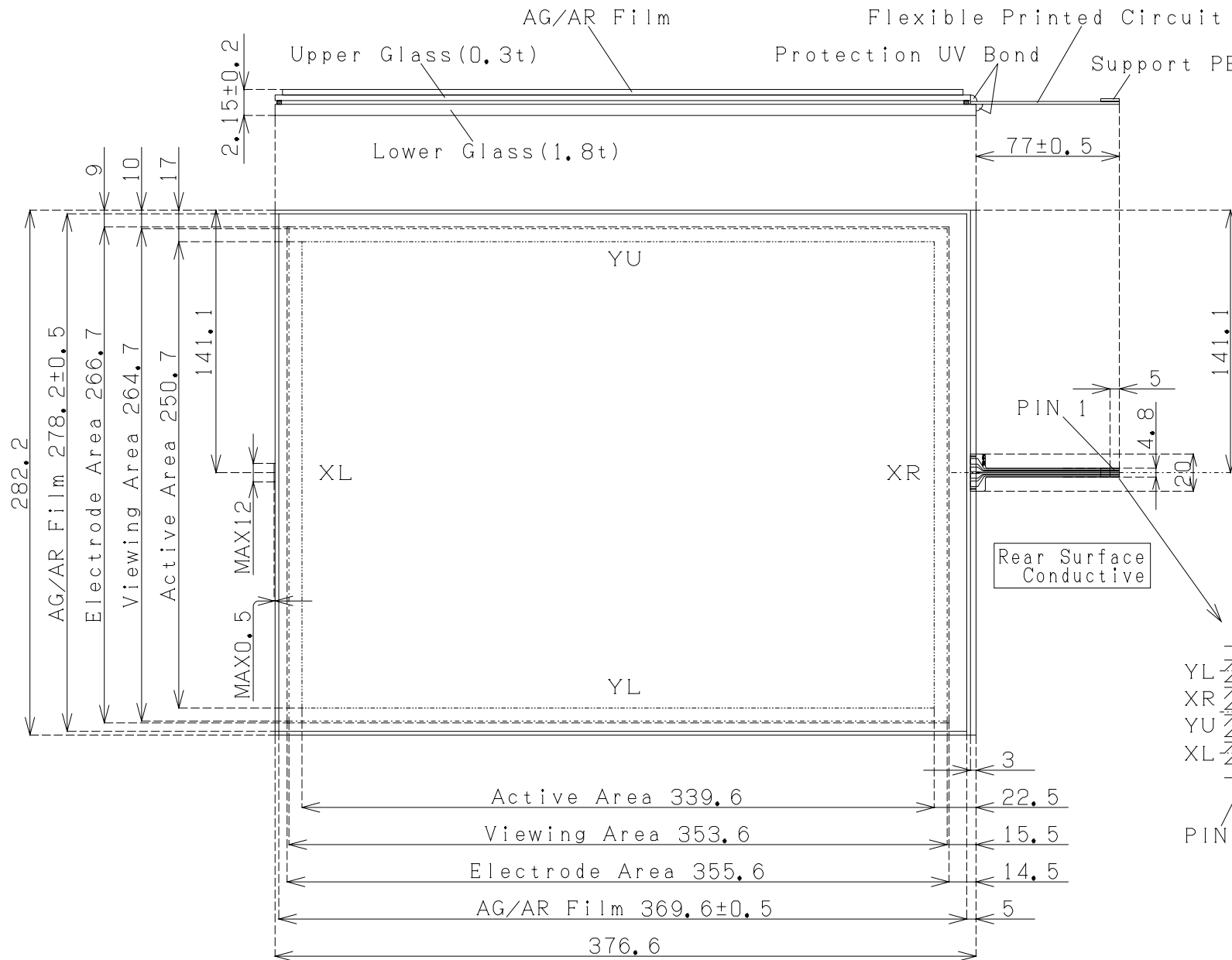

TITLE		ZTP171-25GRF01		DATE '06.6.20	
PART NAME		17.1inch Touch Panel		TOLERANCE ±0.3mm	
NO	DATE	REVISIONS		DRAWN	CHECKED
△					
△					
△					
△					
				Techno Print co.,Ltd.	